







CHIUSINO CIRCOLARE apertura a ribaltamento

-  ROUND manhole cover with back-side opening
-  Trappe RONDE avec ouverture par renversement
-  Tapa CIRCULAR con apertura vertical
-  RUNDE Klapptür flapdoor
-  КРУГЛАЯ крышка люка с откидным открытием
-  圆形人孔盖

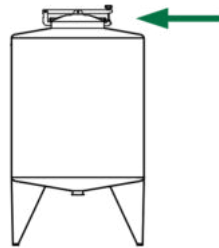

560R SERIE

300/380/400/420/500/600 DN

Rev 0

COPERCHIO COVER	C
TELAIO FRAME	T
BRACCIO ARM	B
VOLANTINO HANDWHEEL	V
GUARNIZIONE GASKET	G

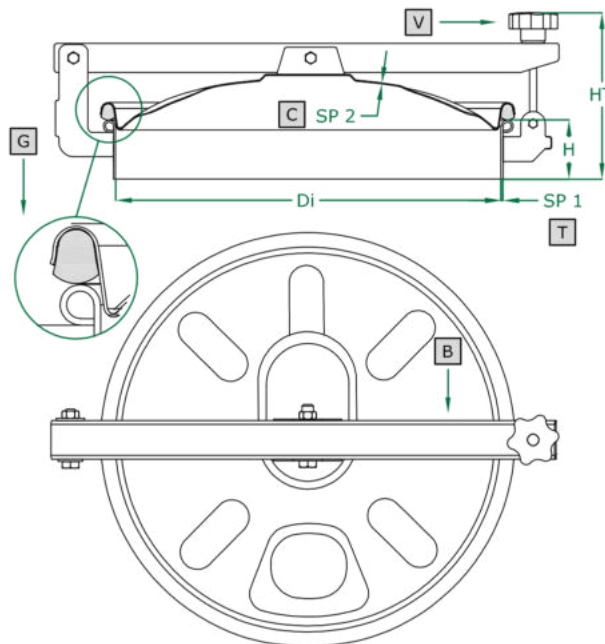

	STANDARD	OPTIONAL				
H X SP1	60 X 2	100 X 2	150 X 2	200 X 2	250 X 2	...
TELAIO	SAT	MPL	BA		FIO	
GUARNIZIONE	EPDM	NEOPRENE	NBR	SILICONE	VITON	
VOLANTINO	125 001 V NYLON	125 021 V NYLON	125 022 CHROME P.	125 023 S. STEEL	125 024 ALUMINIUM	125 031 S: STEEL
FORO	NO	33	42	48	50	...
VALVOLA	NO	VEDI CATALOGO VALVOLE / SEE VALVE CATALOGUE				

ART	DN	DI	SP2	HT (STANDARD)	BAR MAX: (STANDARD)	COVER type:	GASKET code:	KG (STANDARD)
560R	300	295	1,0	140	0,06	CL	120 610	3,5
561R	380	375	1,0	145	0,05	CL	120 611	4,6
562R	400	395	1,2	150	0,05	CN	120 617	5,5
563R	420	415	1,2	150	0,05	CN	120 612	6,0
564R	500	500	1,2	155	0,05	CN	120 616	7,0
565R	600	600	1,5	160	0,04	CL	120 607	9,5